

PCB Sockets for A,B,C,D and G Series sensors

Sensor Type	Manufacturer	Bottom	Pcb Hole Size mm(in)	Tin Shell Tin Contacts	Tin Shell Gold Contacts	Gold Shell Gold Contacts
D toxic	Cambion	Closed	1.40 (0.055)	450-3703-01-04-00	450-3703-01-06-00	450-3703-01-03-00
	Mill-Max	Closed	1.44(0.057)	0667-0-15-80-30-84-10-0	0667-0-15-80-30-27-10-0	0667-0-15-15-30-27-10-0
	Amp Tyco	Closed	1.32 (0.052)	5050462-7	5050462-8	50462-6
D pellistors	Cambion	Closed	1.93 (0.076)	450-3718-01-04-00	450-3718-01-06-00	450-3718-01-03-00
	Mill-Max	Closed	1.93 (0.076)	0294-0-15-80-06-80-10-0	0294-0-15-80-06-27-10-0	0294-0-15-15-06-27-10-0
	Mill-Max	Open	1.70 (0.067) hex press fit	9293-0-15-80-06-80-10-0	9293-0-15-80-06-27-10-0	9293-0-15-15-06-27-10-0
	Amp Tyco	Closed	1.57 (.062)	5050864-6	5050864-1	50864
	Open	Closed	1.91/1.96 (knurled)	H8501-46	H8501-01	H8501-05
	hex press fit	Closed	1.91/1.96 (.075/.077)	H8504-46	H8504-01	H8504-05
A, C and G series	Cambion	Closed	2.59 (.102)	450-3326-01-04-00	450-3326-01-06-00	450-3326-01-03-00
	Mill-Max	Closed	2.54 (0.1)	0364-0-15-80-13-80-10-0	0364-0-15-80-13-27-10-0	0364-0-15-15-13-27-10-0
	Amp Tyco	Closed	2.59 (.102)	not available	not available	2-50871-2
B Series	Cambion	Closed	1.93 (.076)	450-3704-01-04-00	450-3704-01-06-00	450-3704-01-03-00
	Mill-Max	Open	2.35 (.092)	6628-0-18-80-18-80-10-0	6628-0-18-80-18-27-10-0	6628-0-18-15-18-27-10-0
	Mill-Max	Closed	1.91 (.075)	0327-0-15-80-34-80-10-0	0327-0-15-80-34-27-10-0	0327-0-15-15-34-27-10-0
	Amp Tyco	Closed	1.80 (.071)	5050865-8	5050865-5	50865

All sockets are EU RoHS/ELV compliant.

'D' Toxic sensors: An alternative is a single 4-way in-line socket, but as these sockets are designed for square pins, they may not provide the best contact. The sensor will also be spaced off the PCB by the thickness of the socket and will therefore need to be mechanically supported.

Harwin sockets are longer than required and engagement is minimal.

Tyco A sockets are longer than required but engage adequately.

NDIR pins are 1.57 mm diameter, not 1.50 mm. This is the top limit of the A series sockets and insertion/ extraction force must be tested.

The Mil-Max socket allows up to 1.625 mm diameter.

Series	Pin Diameter (mm)	Pin Length (mm)	Pin Spacing (mm)
D toxic	0.64	4.0	2.54 (0.1")
D pellistor	0.80	4.0	3.0 x 5.0
A series and O2-G1/2	1.50	4.3	See data sheets
B toxic	1.00	3.8	See data sheets
NDIR & PID	1.57	4.2	See data sheet

This is not an exhaustive list and is for information and reference purposes only.

Specifications and availability are subject to change and are not in Alphasense's control.

Please contact the appropriate supplier for current details.

Cambion: <http://www.cambion.co.uk/Main/solder1.htm>

Harwin: <http://www.harwin.co.uk/>

Mill-Max: http://www.mill-max.com/pin_rec_catalog/search_results.cfm?pin_or_rec=rec&part_description=Receptacle%20with%20no%20Tail

AmpTyco: <http://catalog.tycoelectronics.com/TE/bin/TE.Connect?C=114&P=&M=LIST&BML=10576,16358,17560,17578&LG=1&l=13&G=G>

Andon Electronics: <http://www.andonelect.com> (see pages 2,3,4 over)

Alphasense Ltd. Gas Sensor Sockets

Alphasense Ltd. Model Number	Andon Part Number Replace "XXX" with Terminal Type	Terminal Type		Pin Ø [in]	Figure Number	Page Number
		Thru-Hole	Surface Mount			
CH-A3	R300-SP03-01T-XXXX-R27-L14	436P55	440P55	.060	27	2
CH-D3	R196-SP04-01T-XXXX-R27-L14	295V	439V	.030	12	2
CL2-A1	R530-0403-02N-XXXX-R27-L14	436P55	440P55	.060	38	3
CL2-B1	R670-0804-02T-XXXX-R27-L14	433E	285E	.040	44	3
CL2-D4	R300-SP04-02T-XXXX-R27-L14	295V	439V	.030	26	2
CO2-D1	R200-SP03-03T-XXXX-R27-L14	295V	439V	.030	17	2
CO-AE	R530-0403-02N-XXXX-R27-L14	436P55	440P55	.060	38	3
CO-AF	R530-0403-02N-XXXX-R27-L14	436P55	440P55	.060	38	3
CO-AX	R530-0403-02N-XXXX-R27-L14	436P55	440P55	.060	38	3
CO-BF	R670-0804-02T-XXXX-R27-L14	433E	285E	.040	44	3
CO-BX	R670-0804-02T-XXXX-R27-L14	433E	285E	.040	44	3
CO-CE	R530-0403-02N-XXXX-R27-L14	436P55	440P55	.060	38	3
CO-CF	R530-0403-02N-XXXX-R27-L14	436P55	440P55	.060	38	3
CO-CX	R530-0403-02N-XXXX-R27-L14	436P55	440P55	.060	38	3
CO-D4	R300-SP04-02T-XXXX-R27-L14	295V	439V	.030	26	2
D2	R300-SP04-02T-XXXX-R27-L14	295V	439V	.030	26	2
ETO-A1	R530-0403-02N-XXXX-R27-L14	436P55	440P55	.060	38	3
ETO-B1	R670-0804-02T-XXXX-R27-L14	433E	285E	.040	44	3
H2S-A1	R530-0403-02N-XXXX-R27-L14	436P55	440P55	.060	38	3
H2S-AE	R530-0403-02N-XXXX-R27-L14	436P55	440P55	.060	38	3
H2S-AH	R530-0403-02N-XXXX-R27-L14	436P55	440P55	.060	38	3
H2S-B1	R670-0804-02T-XXXX-R27-L14	433E	285E	.040	44	3
H2S-BE	R670-0804-02T-XXXX-R27-L14	433E	285E	.040	44	3
H2S-BH	R670-0804-02T-XXXX-R27-L14	433E	285E	.040	44	3
H2S-D4	R300-SP04-02T-XXXX-R27-L14	295V	439V	.030	26	2
HCN-A1	R530-0403-02N-XXXX-R27-L14	436P55	440P55	.060	38	3
HCN-D4	R300-SP04-02T-XXXX-R27-L14	295V	439V	.030	26	2
IRC-A1	R505-SP07-01T-XXXX-R27-L14	436P55	440P55	.060	32	2
NO2-A1	R530-0403-02N-XXXX-R27-L14	436P55	440P55	.060	38	3
NO2-AE	R530-0403-02N-XXXX-R27-L14	436P55	440P55	.060	38	3
NO2-B1	R670-0804-02T-XXXX-R27-L14	433E	285E	.040	44	3
NO2-D4	R300-SP04-02T-XXXX-R27-L14	295V	439V	.030	26	2
NO-A1	R530-0403-02N-XXXX-R27-L14	436P55	440P55	.060	38	3
NO-AE	R530-0403-02N-XXXX-R27-L14	436P55	440P55	.060	38	3
NO-B1	R670-0804-02T-XXXX-R27-L14	433E	285E	.040	44	3
NO-D4	R300-SP04-02T-XXXX-R27-L14	295V	439V	.030	26	2
O2-A1	R530-0403-02N-XXXX-R27-L14	436P55	440P55	.060	38	3
O2-A2	R530-0403-02N-XXXX-R27-L14	436P55	440P55	.060	38	3
O2-A3	R530-0403-02N-XXXX-R27-L14	436P55	440P55	.060	38	3
O2-C2	R530-0403-02N-XXXX-R27-L14	436P55	440P55	.060	38	3
O2-G1	R530-0403-02N-XXXX-R27-L14	436P55	440P55	.060	38	3
O2-G2	R530-0403-02N-XXXX-R27-L14	436P55	440P55	.060	38	3
PH3-A1	R530-0403-02N-XXXX-R27-L14	436P55	440P55	.060	38	3
PH3-B1	R670-0804-02T-XXXX-R27-L14	433E	285E	.040	44	3
PH3-BE	R670-0804-02T-XXXX-R27-L14	433E	285E	.040	44	3
PID-A1	R300-SP03-01T-XXXX-R27-L14	436P55	440P55	.060	27	2
PID-AH	R300-SP03-01T-XXXX-R27-L14	436P55	440P55	.060	27	2
SO2-AE	R530-0403-02N-XXXX-R27-L14	436P55	440P55	.060	38	3
SO2-AF	R530-0403-02N-XXXX-R27-L14	436P55	440P55	.060	38	3
SO2-BF	R670-0804-02T-XXXX-R27-L14	433E	285E	.040	44	3
SO2-D4	R300-SP04-02T-XXXX-R27-L14	295V	439V	.030	26	2

©Copyright 2011 Andon Electronics Corporation. All Rights Reserved. This material is protected under US and other copyrights and may not be copied, sold, or redistributed in any form without written permission of Andon Electronics Corporation. Copyrights and trademarks are property of their respective companies. We reserve the right to change specifications without notice.

Andon makes no warranty, expressed or implied, as to the suitability of the sockets for the intended purpose.



RoHS Compliant
ISO 9001
Certified

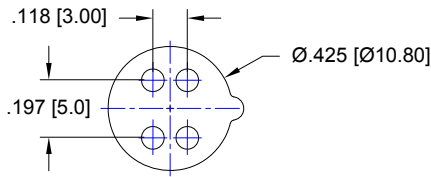

Fig 12

Thru-hole: R196-SP04-01T-295V-R27-L14
Surface Mount: R196-SP04-01T-439V-R27-L14

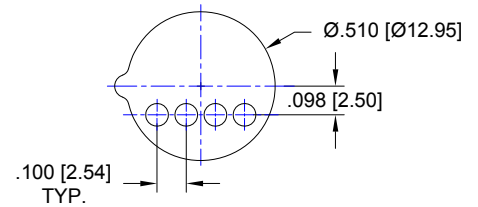
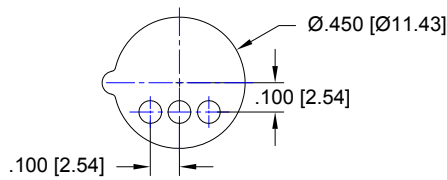

Fig 17

Thru-hole: R200-SP03-03T-295V-R27-L14
Surface Mount: R200-SP03-03T-439V-R27-L14

Fig 26

Thru-hole: R300-SP04-02T-295V-R27-L14
Surface Mount: R300-SP04-02T-439V-R27-L14

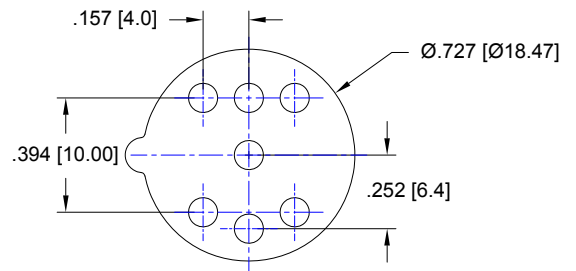
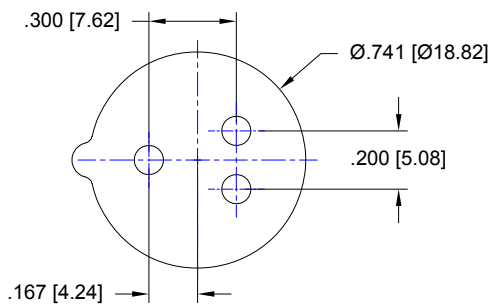

Fig 27

Thru-hole: R300-SP03-01T-436P55-R27-L14
Surface Mount: R300-SP03-01T-440P55-R27-L14

Fig 32

Thru-hole: R505-SP07-01T-436P55-R27-L14
Surface Mount: R505-SP07-01T-440P55-R27-L14

*Sockets are not drawn to scale.

©Copyright 2011 Andon Electronics Corporation. All Rights Reserved. This material is protected under US and other copyrights and may not be copied, sold, or redistributed in any form without written permission of Andon Electronics Corporation. Copyrights and trademarks are property of their respective companies. We reserve the right to change specifications without notice.
Andon makes no warranty, expressed or implied, as to the suitability of the sockets for the intended purpose.



RoHS Compliant
ISO 9001
Certified

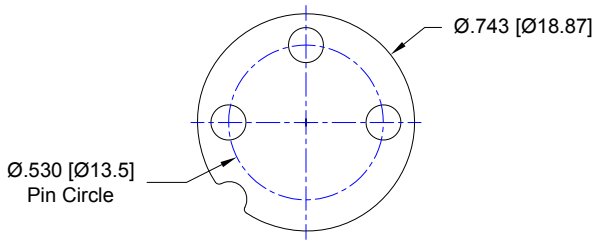

Fig 38

Thru-hole: R530-0403-02N-436P55-R27-L14
 Surface Mount: R530-0403-02N-440P55-R27-L14

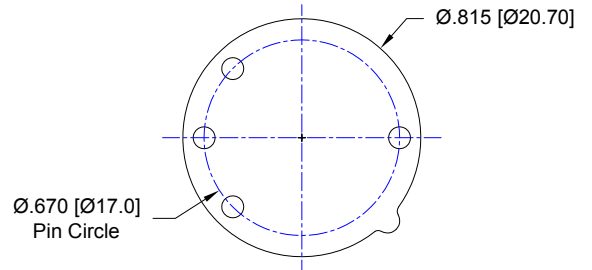
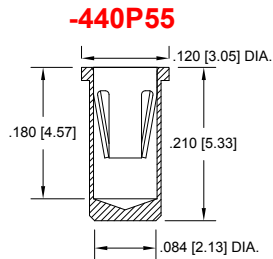
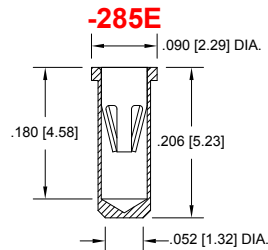
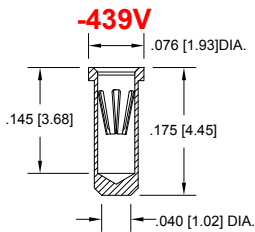
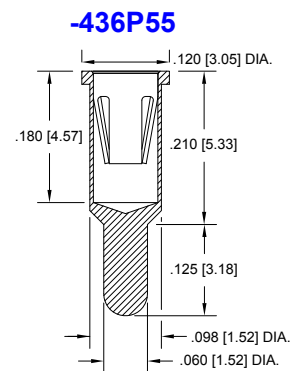
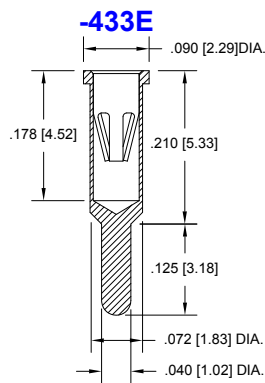
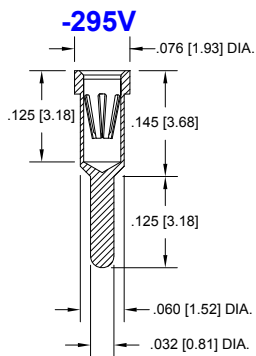

Fig 44

Thru-hole: R670-0804-02T-433E-R27-L14
 Surface Mount: R670-0804-02T-285E-R27-L14

Socket Terminal Details

Cross Section View Shown Units: in [mm]



Technical Information

Material: OTHER PLATINGS AVAILABLE

Insulator: Hi-Temp UL 94V-O

Terminal: Brass, per ASTM-B16

Contact: BeCu, Per ASTM-B194

Plating: RoHS COMPLIANT
 R27 TERMINAL: GOLD / CONTACT: GOLD
 R17 TERMINAL: TIN / CONTACT: GOLD

Terminal Acceptance and Forces

Thru Hole Terminals				Surface Mount Terminals			
Thru Hole Terminal	Accepts Pin Diameter	Insertion Force	Withdrawal Force	Surface Mount Terminal	Accepts Pin Diameter	Insertion Force	Withdrawal Force
-295V	Ø.030 [Ø0.76]	13.2 oz Max	3.5 oz Min	-439V	Ø.030 [Ø0.76]	13.2 oz Max	3.5 oz Min
-433E	Ø.040 [Ø1.02]	36.0 oz Max	3.9 oz Min	-285E"	Ø.040 [Ø1.02]	36.0 oz Max	3.9 oz Min
-436P55	Ø.060 [Ø1.52]	15.5 oz Max	2.1 oz Min	-440P55	Ø.060 [Ø1.52]	15.5 oz Max	2.1 oz Min

MOUNTING OPTIONS

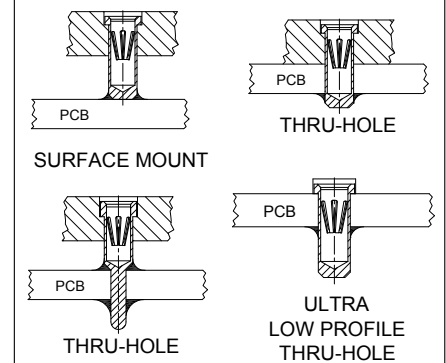

*Sockets are not drawn to scale.

©Copyright 2011 Andon Electronics Corporation. All Rights Reserved. This material is protected under US and other copyrights and may not be copied, sold, or redistributed in any form without written permission of Andon Electronics Corporation. Copyrights and trademarks are property of their respective companies. We reserve the right to change specifications without notice.

Andon makes no warranty, expressed or implied, as to the suitability of the sockets for the intended purpose.



RoHS Compliant
ISO 9001
Certified